

WISEGUY

*Simitar Series
By Bill Evans*

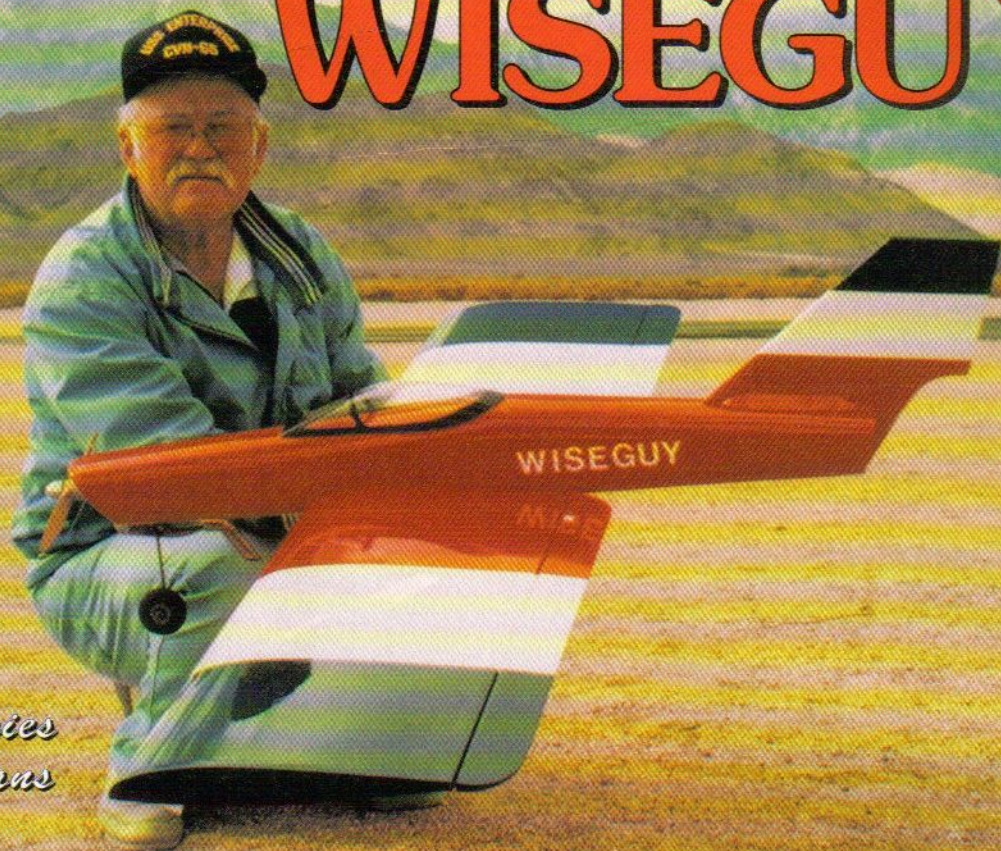

Whether You're A Novice Or An Expert, Here's A 21st Century Simitar For You.



*Tom Titolo,
Atascadero,
CA, with his
WiseGuy
which is
glassed and
painted.*

The real reason we take up a pastime hobby is to have fun and get relief from daily problems related to complexity, pressure, and stress. It is fun to get out and do what you want to do, the way you want to do it, and when you want to do it. To continue the above thought, when we get into the R/C hobby, we want an airplane that is easy to fly (not something you have to fight to keep in the air). We also want something that is easy to build.

The Wiseguy fits the above bill. It is so easy to fly that it rates high in the Simitar class of FBI (Flies By Itself) aircraft. The ship is so aerodynamically stable that I can give the transmitter to my five year old granddaughter, Lindsay, and I go for a cup of coffee while it continues gentle 360° turns at a constant altitude. I can put the transmitter in the hands of anyone of any age and they fly, loop, and roll on their first flight.

Using CA adhesive, Wiseguy fuselage construction takes about an hour, ready for sanding. The wing is foam, and construction takes about two hours. Add another couple of hours for other parts and sanding, then you are ready to cover. Covering takes me



Bill on a roll, nose up, wheels down, airborne.

about six hours; I just can't do it faster. Then another six hours to install engine, radio, and other components, and you are ready to fly.

Wiseguy is the 86th design in the Simitar Series. The first Simitar-type aircraft appeared over twenty years ago when I designed the Saracen glider (*RCM* construction article April '76, Plan #639). The Saracen was the test bed for all Simitars to

follow. Flown off slopes and hi-start, sizes ranged from 48" to 120" spans. Interest began to grow. The Saracen was a flying wing using elevons (combined elevator and ailerons using the same control surfaces). We were all amazed at how aerodynamically stable it was, and how it just would not stall. As you gradually pull back on the stick and slow the Saracen down, it would not

drop the tail and roll off in a tip stall. It would merely drop the nose and keep flying! So, if it flew that good as a glider, how about a powered version?

At this point, I should explain where the term Simitar came from. When I was working on the construction article for the first powered version for *RCM*, Dick Kidd said, "What are you going to name this one?"

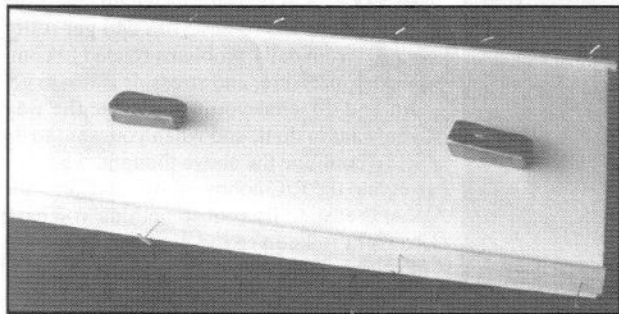

LEFT: Glue and pin 3/16" balsa leading edge undercap and 1/4" balsa trailing edge to cores. Use CA UFO or carpenter's glue. **RIGHT:** Trim, plane, and sand the balsa leading edge undercap and trailing edge to match the airfoil contour.

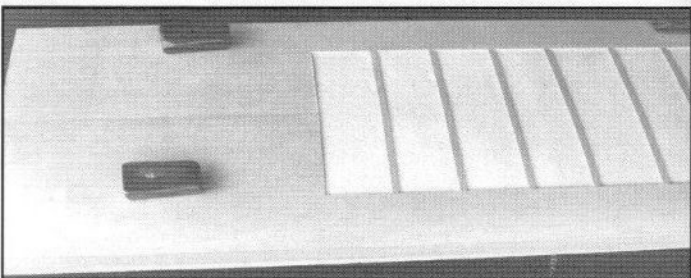
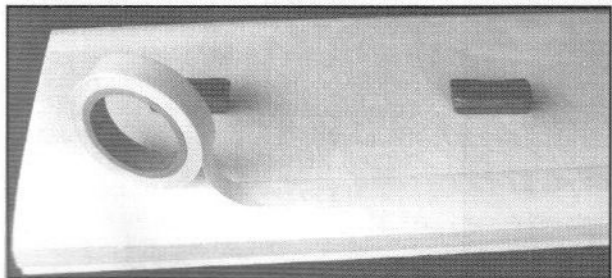
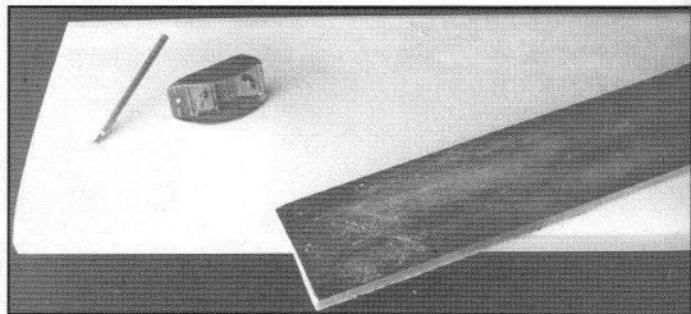

LEFT: Apply two strips of Corefilm to leading and trailing edges of cores. Remove paper backing and place 1/16" x 2" balsa sheeting in place on foam and smooth down. **RIGHT:** Add inboard sheeting and glue the 1/16" x 1/4" capstrips in place (on 2" centers).

THE BIG LAZY BEE

NEW FROM
CLANCY AVIATION

The **NEW BIG Lazy Bee** is finally here for modelers who fly **BIG** planes. It has the same amazing low speed flying characteristics as the smaller Lazy Bee. These amazing characteristics are why Cox decided to manufacture the Cox RTF Lazy Bee under license from us. We could go on and on about tight turns, short take-offs, snap rolls, hands-off stability that gives it the ability to self-recover from any attitude, super slow stall speed - But we won't! Seeing is Believing! Get our 35 min video and see the Lazy Bee perform aerobatics, taxi over 2 x 4's, fly on floats with gas & electric power, fly in formation with ducks, and more! New low price - just \$10 including shipping!

By the way, if you have a hard time reading our tiny print, you **really** should get a Lazy Bee - it's so easy to see!

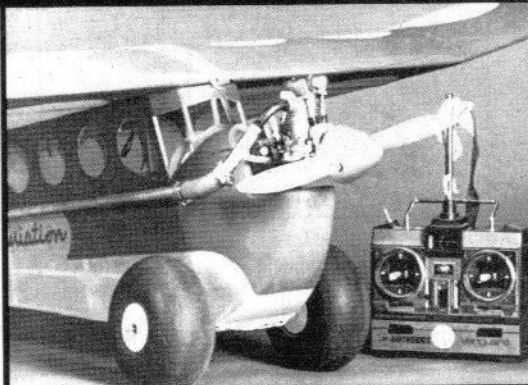

BIG LAZY BEE

60" WING
\$109

72" WING
\$119

FREE SHIPPING INSIDE USA

- The Big Plane You Can Fly In Small Places
 - Flies Just Like The Original Lazy Bee
 - Accepts 25 to 45 2-Cycle Or Electric 45 To 70 4-Cycle
 - Super Low Wing Loading 7.8 to 11.2 oz/sq ft!
 - **BIG** Wing Area: Over 8 Sq Ft (Std 60" Wing) 10 Sq Ft (72" Extended Wing!)
 - Optional Removable Tail For Easy Transport
 - Optional Bolt-on Wing
- Kit includes computer drawn plans, with covering patterns, detailed instruction book, Pre-cut Balsa and Plywood parts, carbon fiber, stainless steel, bamboo parts, and plastic iron-on for windows.

THE COX READY-TO-FLY LAZY BEE

Just shake it out of the box and go flying! The huge wing makes it ideal for beginners. Experts will enjoy the responsive oversized control surfaces.

.049 powered, 39" span without radio - **ONLY \$109** - FREE SHIPPING IN US
OR, with 2 channel 27 MHz 2-stick radio - **ONLY \$179** - FREE SHIPPING IN US

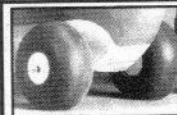
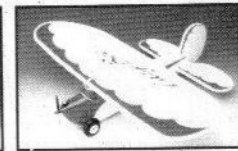
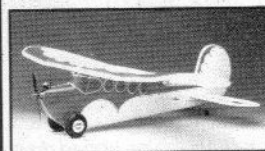

TREXLER BALLOON WHEELS NEW SIZE 6" DIA

We carry the full line of these great inflatable wheels. The awesome shock absorbing ability and light weight have made these wheels the choice of modelers who demand the best since 1936! Available in sizes from 1" to 6" diameter, for planes from 6 oz to 25 lbs!

NEW & IMPROVED ORIGINAL LAZY BEE

Standard (40" wing) Kit - \$54 - Extended Wing (48" wing) Kit - \$60 - Float Kit - \$24



- Our Low Price Guarantee! We will beat all advertised Lazy Bee Prices!
- Prices include Priority Mail shipping.



Convert from a land plane to a float plane in only 2 minutes! Our improved Lazy Bee kits feature: New computer drawn plans, expanded instruction book, optional bolt-on wing & removable tail, and a quick access battery door for electric flyers. We recommend the 40" version for most glow engines and for aerobatics and the 48" extended wing for training, gliding, four-cycle engines and electric power.

New!! Electrification Combination Only \$119!

1589 wire Charger - Our new electric combo pack for the 48" Lazy Bee has all you need to get started flying electric. It includes a Master Aniscrew .05 gear drive motor, Astro Flight 217 micro speed control, 7 cell Sanyo 1300 mAh Battery pack, APC 11x7 prop, and Hi-Tec peak detector quick charger. This system gives 6 exciting minutes of full throttle loops, rolls, hammerheads, etc. - OR a much longer flight relaxed & throttled back. Great for 'foal flying' too! Seeing is believing - it's in the video!

For Quick Service Call:
(602) 649-1534

8 a.m. to 5 p.m. MST M-F
CREDIT CARD & COD ORDERS ACCEPTED

CLANCY AVIATION
219 W 2nd AVE.
MESA, AZ 85210-1317

For more info, send for our new catalog - \$2 Free Catalog with any purchase. ALL PRICES INCLUDE SHIPPING INSIDE THE U.S.

I had to do some thinking. It took a while but the resulting thought process was: Since the original of my flying wings was the Saracen (airy sounding like "air-a-cen"); and, the Saracens fought the Crusaders in the holy wars using curved swords, it followed that the power of the Saracens was in these curved swords called Simitars. Therefore, the first powered Saracen was named the Simitar. Next in line came the Simitar .15, the Simitar 540, and many more, so that

today, the Simitar is a distinct class of aircraft. Even though development of the powered versions resulted in longer fuselages that take away the look of a flying wing, aerodynamic performance and stability have been retained. Some call the Wiseguy the F.B.I., that is, Flies By Itself; and others call it the K-12, meaning suitable for kindergarten through high school, because if you slow it down and give easy gentle control, it will fly like a glider, or if you give it full

power and push controls to the max, it will respond with full aerobatics as fast as you can input the control movement.

Wiseguy's performance is due to its inclusion in the Simitar Series. Many times it has been said to me, "Why do you fly Simitar Series aircraft? Must be because you designed them." My answer is, "Performance."

Yes, performance. First, no stall ... reduce power gradually while you slowly feed in up elevator; as it slows down, the nose will

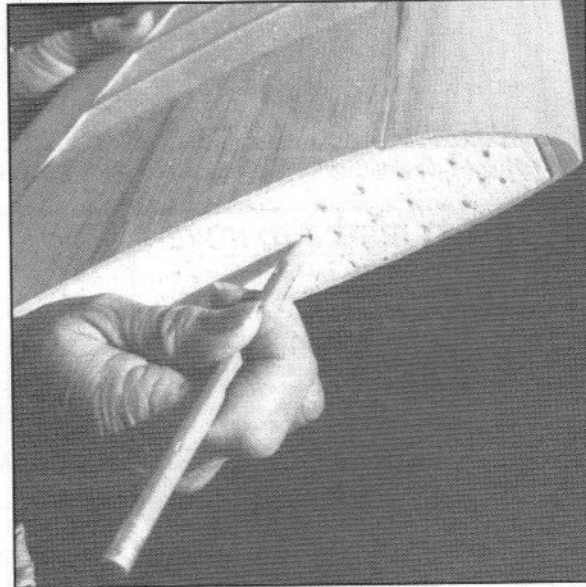
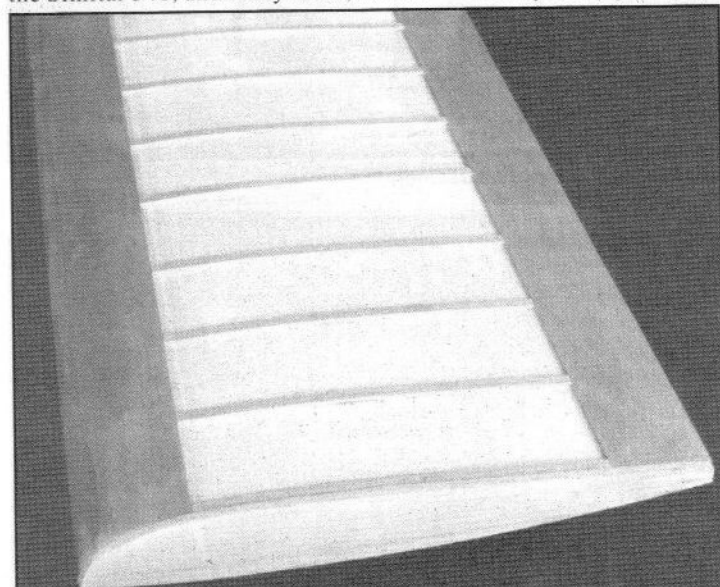

LEFT: After sheeting bottom of wing panel, sand undercap flush with sheeting. Cement and trim the 1/4" leading edge cap to shape shown on plans. Note the steep top on leading edge and fairly flat bottom. RIGHT: Center section of wing. Punch holes in root prior to joining wing halves with 5-minute epoxy. Note 1/4" balsa leading edge cap.

3W-Modellmotoren Single & Multi-Cylinder Engines that Provide Awesome, Smooth, Reliable Power!

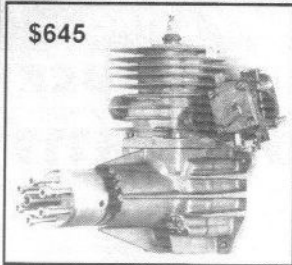

\$645

3W-60
3.7 in³
5.6 HP
5.3 lbs.
22 x 10

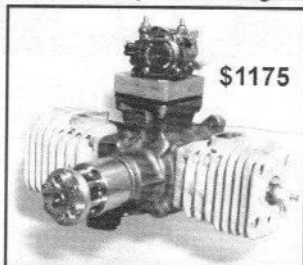

\$1175

3W-70B2
4.2 in³
6.5 HP
4.9 lbs.
24 x 10



3W-120B2
WINS
1994 T.O.C.I

\$1450

3W-120B2
7.0 in³
12.0 HP
8.8 lbs.
28 x 12

1st, 2nd, 5th, 6th, 8th & 15th Places at 1994 Tournament of Champions Powered by 3W!

All gas motors include Solid-State, Auto-Advance, Electronic Ignition! All motors have 3 or more crankshaft ball bearings. All 3W two, four, and six-cylinder motors feature reed valves and Schnuerle porting. 3W motors are manufactured in Germany and are guaranteed for one full

Dave Johnson's Desert Aircraft, P.O. Box 18038 Tucson, AZ 85731, Phone/FAX (602 or 520) 722-0607

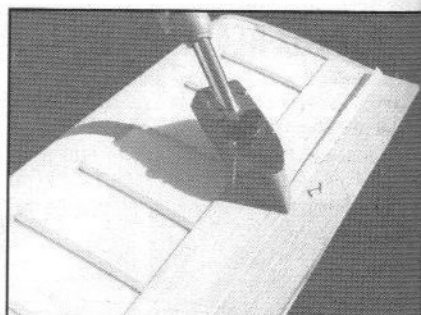
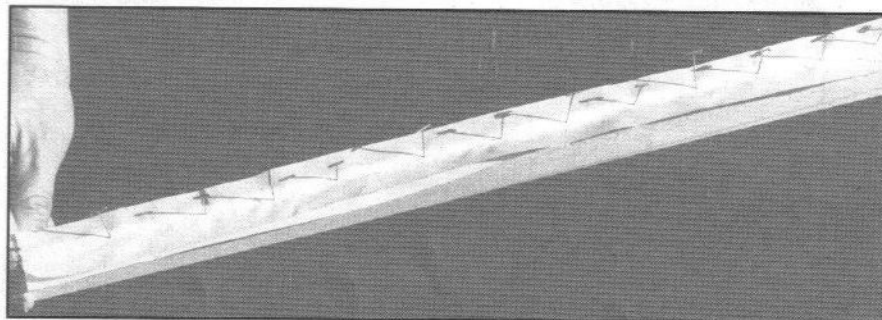

LEFT: Pin hinge to edge of control surface, be sure to keep stitch centered. RIGHT: Elevon pinned in place on wing, X-Hinge being ironed down.

automatically drop a bit, this reduces the angle of attack; therefore, no stall. Next, the wide speed range ... no matter how much power you put to a ship of the Simitar Series, it just goes faster, no "Dutch Roll." It also slows down to a crawl (effect of no stall) and sets down like a hang glider. Finally, a Simitar is directional in flight as it will remain in any attitude it is set in. Blip a little

left aileron, let go, and it will hold in a left turn (no trim set); barring severe winds, it will hold 360's, one after the other.

Now, add flying in winds up to 60 mph, hovering inverted, and backing up mid-air in the same wing. Add vertical landings and vertical take-offs (recorded on VHS). To explain what the Wiseguy can do in its entirety would take too long;

to say what it cannot do is most simply put by saying, "The Wiseguy violates all limits of what some hold true."

Also, for the record, the fastest aircraft in the world, the SR-71 Blackbird, is a flying wing; it has no conventional aft mounted horizontal stabilizer. Neither does the fastest people mover, the Concord; nor does the world distance

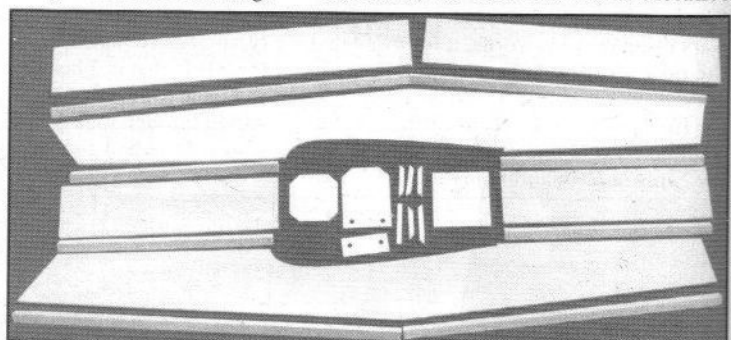
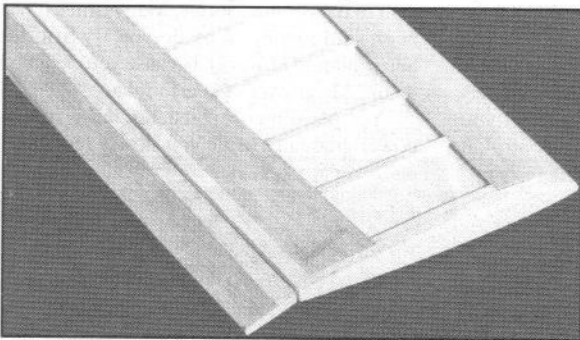

LEFT: Hinge complete, no air gap, free action. RIGHT: Fuselage parts cut and ready for assembly.

TEACH YOURSELF TO HOVER

THE UNIQUE DESIGN OF THE **WHITEMAN FLYING STAND** ALLOWS SMOOTH, NORMAL HELICOPTER MOVEMENTS. BANKING, PITCHING, ROTATING 360° WHILE RISING TO A HEIGHT OF 4' IN A 12" DIA. CIRCLE. A GAS FILLED STRUT COUNTERBALANCES THE STAND. YOUR HELI DOESN'T LIFT EXTRA WEIGHT. THIS STAND GIVES YOU **MORE CONTINUOUS PRACTICE TIME** TO GAIN YOUR EYE-HAND COORDINATION. SO YOU LEARN TO **HOVER SOONER** AND WITH **LESS EXPENSE**. WHEN YOU CAN HOVER YOUR HELI "ON" THE STAND, YOU ALSO WILL BE ABLE TO HOVER IT "OFF" THE STAND.

FEATURES: PRACTICE IN A DRIVE-WAY, BACK YARD, TWO CAR GARAGE • ALL ALUMINUM CONSTRUCTION • BALL BEARINGS • ASSEMBLES IN TWO HOURS • PORTABLE, 42" LONG • SPRING LOADED CASTER, WORKS ON PAVEMENT OR GRASS • J-BOLTS HOOK OVER HELI'S SKIDS AND HOLD IT FIRMLY IN PLACE. • IT'S ALSO A TEST STAND FOR RADIO, ENGINE AND LINKAGE ADJUSTMENTS • **LEARN NOSE-IN HOVER!!!**

\$199.99 THE PRICE OF ONE OR TWO CRASHES!!!

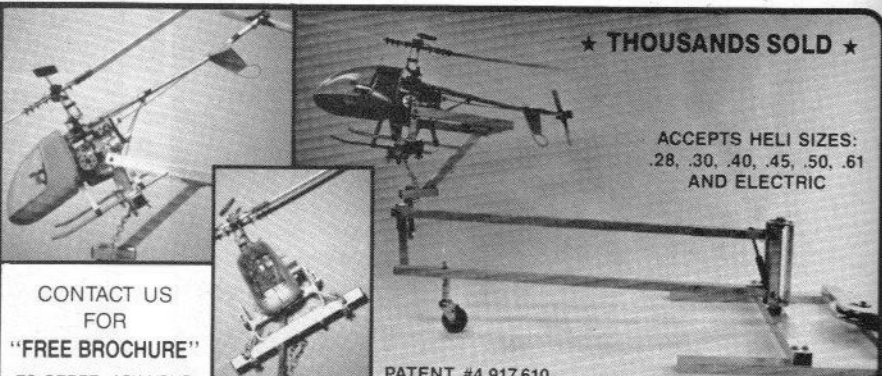

★ THOUSANDS SOLD ★

ACCEPTS HELI SIZES:
28, 30, 40, 45, 50, 61
AND ELECTRIC

CONTACT US
FOR
"FREE BROCHURE"

TO ORDER: ASK YOUR
LOCAL HOBBY STORE
OR ORDER DIRECT

PATENT #4,917,610

**WHITEMAN INT., 3600 OSUNA RD. N.E. #321, ALBUQUERQUE,
NM 87109, U.S.A. • PH: (505) 345-1859, FAX (505) 345-1928**

SALES AND SERVICE FOR EVERYTHING R/C



KRAFT MIDWEST INC.,
7420 SEVEN MILE, NORTHVILLE, MI. 48167
810-486-4800 FAX 810-486-1803

SERVO MATE

Size. 1.75" x 2.75" x 1.30"
Use to install and check servos
Drives ANY modern servo
Drives MULTIPLE servos
Use your favourite connectors
Accurate neutral settings
Uses your spare nicad pack



Model:
KMI-921
\$24.95
Model:
KMI-921K
(kit) \$19.95
shipping and
insurance extra
Mastercard &
VISA

SERVICE

ACE*, AIRTRONICS*, ARISTO-CRAFT, CIRRUS, FUTABA, HITEC*, JR*,
HOBBY-SHACK, K-LINE*, KO PROPO*, KRAFT*, NOVAK, PRO-LINE, RCD*,
TOWER HOBBIES, *FACTORY TRAINED. WARRANTY ON SOME BRANDS.
Hours: 8.00 am - 5.00 pm EST weekdays, call for Saturday hours. SAE for catalog.

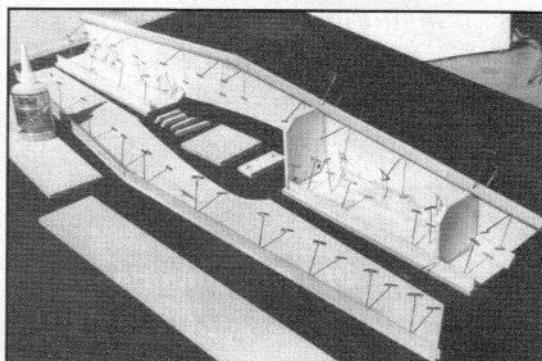
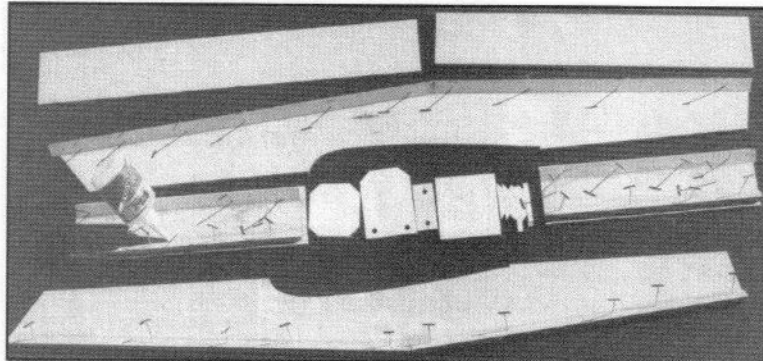

LEFT: Fuse front and rear bottom pieces pinned to work surface, 1/2" tri. pinned to bottom pieces and to top inside edges of sides, note CA thin is run on inside edge only as shown. RIGHT: First side pinned in place with former and fire wall.

CONSTRUCTION

For those who do not cut foam, you may order cores for the Wiseguy from: Soaring Research, 454 Wildrose Lane, Bishop, CA 93514, (619) 873-4932.

Cores are \$20.00 and shipping is \$7.00.

Wing:

Make sure the wing panels are flat and straight; use weights with the core on a flat surface if necessary. Cement the 3/16"

record holder (goes into space and returns), the Shuttle. Ever wonder why? Could it possibly be performance?

Yes, I know, you need to have a Wiseguy, so let's begin construction.

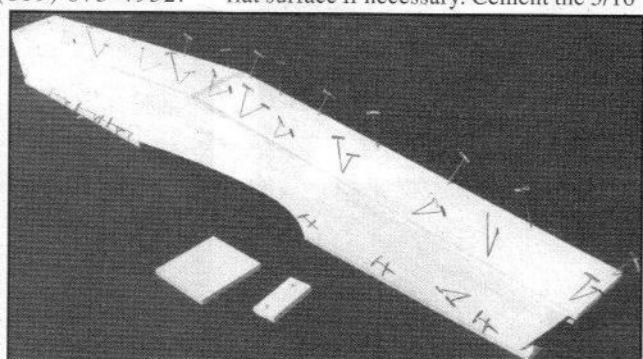
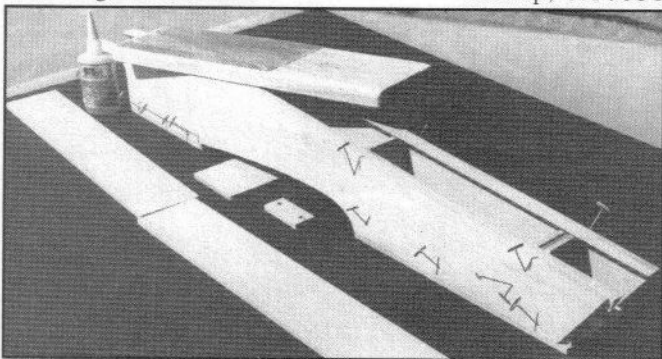

LEFT: Pin and CA second side in place, then sand top flush before applying top pieces. RIGHT: Top pieces in place, fuse construction is basically complete.

WISEGUY

Designed by:

Bill Evans

TYPE AIRCRAFT

21st Century Simitar Series

WINGSPAN

64 Inches

WING CHORD

14 Inches

TOTAL WING AREA

890 Sq. In.

WING LOCATION

Bottom Of Fuselage

AIRFOIL

ESA (Evans Simitar Airfoil)

Semi-Symmetrical Reflexed

WING PLANFORM

Constant Chord

DIHEDRAL, EACH TIP

1/2 Inch

OVERALL FUSELAGE LENGTH

42 Inches

RADIO COMPARTMENT SIZE

(L) 10" (W) 2-1/2" (H) 2-1/2"

VERTICAL FIN HEIGHT

10 Inches

VERTICAL FIN WIDTH (inc. rud.)

9 Inches (Avg.)

REC. ENGINE SIZE

.25-.60 2-Stroke

FUEL TANK SIZE

4-8 Ounces

LANDING GEAR

Tricycle

REC. NO. OF CHANNELS

4

CONTROL FUNCTIONS

Throt., Elevons, Nose Wheel

C.G. (from L.E.)

1-1/2" Approx. (Empty Fuel Tank)

ELEVATOR THROWS

3/8"-1/2" Up — 3/8"-1/2" Down

AILERON THROWS

3/8"-1/2" Up — 3/8"-1/2" Down

RUDDER THROWS

NA

SIDETHRUST

NA

DOWNTHRUST/UPTHRUST

NA

BASIC MATERIALS USED IN CONSTRUCTION

Fuselage Balsa & Ply

Wing Balsa, Ply, Foam Core

Empennage Balsa

Wt. Ready To Fly .. 72 Oz. (4 Lbs. 8 Oz.)

Wing Loading 13-1/2 Oz./Sq. Ft.

JETT *The Only Way To Fly.*

Most Jett Engines are available in .40, .46, .50, .65 & .76 sizes, and like all Jett Engines, are the most powerful...at any price.

Call or write today and find out why Jett is ...

The Only Way to Fly.

Available Directly from

JETT Engineering

6110 Milwee, Suite J • Houston, TX 77092

Phone: 713-680-8113 • Fax: 713-680-8164

Made in the U.S.A.

Coming soon from JETT...
Sport-Jett .90 Lite

Dealer Inquires Welcome

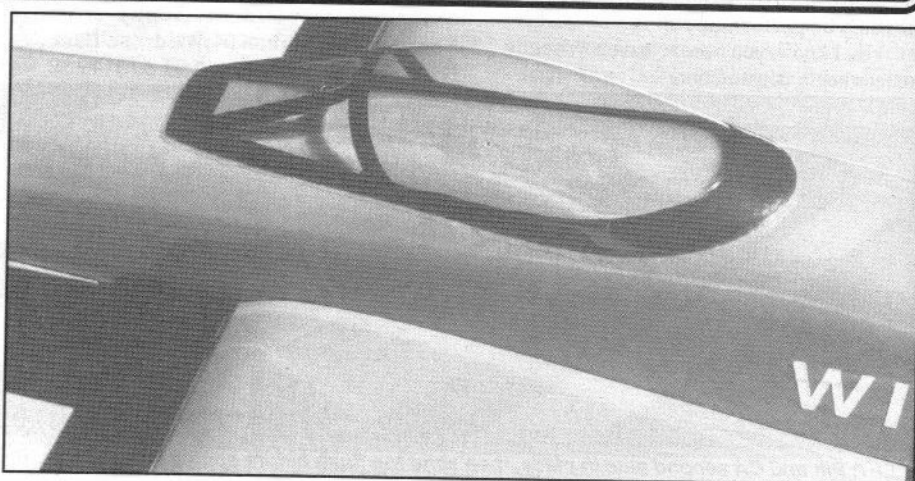
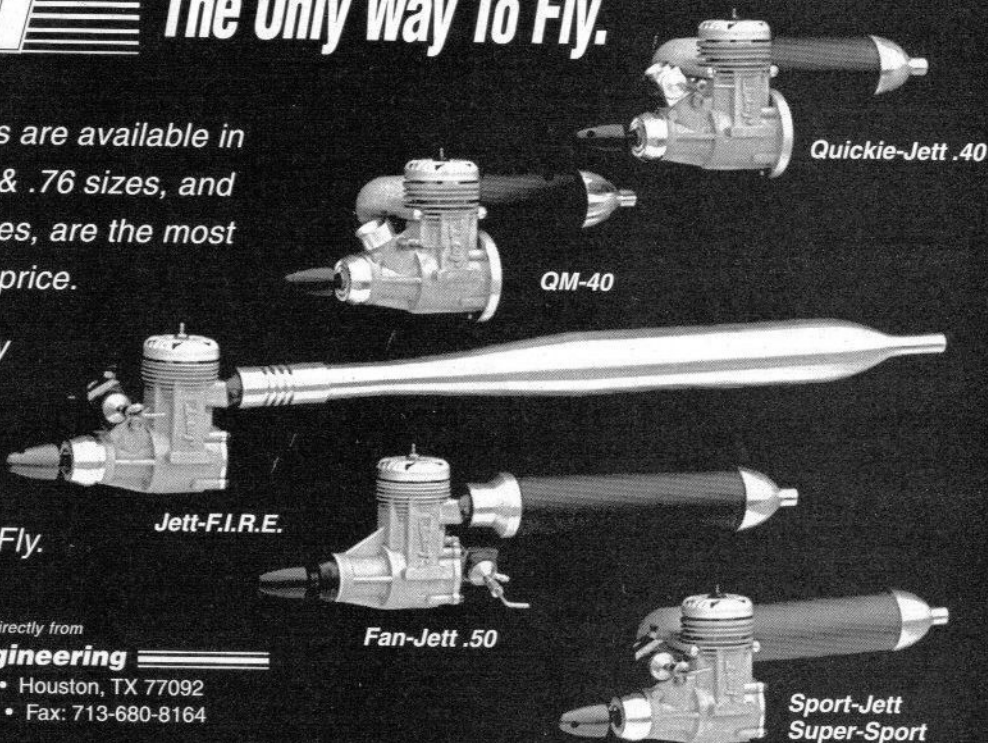

LEFT: Detail of K&B .40 mounted with Evans EZ Mount. RIGHT: Canopy detail.

balsa leading edge undercap to the leading edges, and the 1/4" balsa trailing edge to the trailing edges. Use CA UFO or carpenter's glue; do not use regular CA on foam; set these aside to dry.

Fuselage:

Cut out the balsa fuselage pieces, plywood fire wall, bulkhead, and wing plate. Match drill the bulkhead and wing plate with 1/4" diameter holes for the retaining dowels. Place fuselage front and rear bottom pieces on a flat work surface, and separate them by the width of the wing cut-out. Use the fuselage sides to line them up, then pin the front and rear bottom pieces to the work surface.

Mark the location of the fire wall and

bulkhead on the fuselage sides and front bottom. Pin the 1/2" triangle longerons onto the fuselage front bottom and rear bottom, 1/4" from the outer edge (to allow the fuselage sides to fit flush on the outside). Now apply thin CA to the longeron inside edges only (the CA will run under the triangle stock and bond to the fuselage bottom).

Pin the top pieces of the 1/2" triangle longerons to the top inside edge of the fuselage sides (flush with the top edge of the sides) and apply CA to the longeron/fuselage inside edge.

Remove the pins from the 1/2" longerons (the CA should be set). Pin one of the fuselage sides in place onto the bottom pieces

against the 1/2" triangle longerons. Run CA between the fuselage side and the 1/2" triangle. Now set the fire wall into place and apply CA; do the same for the plywood bulkhead. Pin the second fuselage side into place and apply CA to longerons, fire wall, and bulkhead. Pin and CA 1/4" x 1/4" strips around rear outer edge of fire wall.

After the CA is set, carefully remove all pins, sand the top edges of the fuselage sides so the top front and rear pieces will fit flat, then pin and CA them into place. When the CA is set up, trim and sand the rear end flat; pin and CA the fuselage rear end closure in place. Fuselage construction is now complete! Round the fuselage corners and apply sandpaper.

ISO-MOUNTS[®] by SoundMaster[®]

The Original Soft Mount

"It's Simplicity Itself"

- Reduces noise
- Tunes out engine vibration
- Installs in minutes!
- No blind nuts required
- Variable dampening
- Allows easy thrust line adjustments
- Works with any 1 piece motor mount

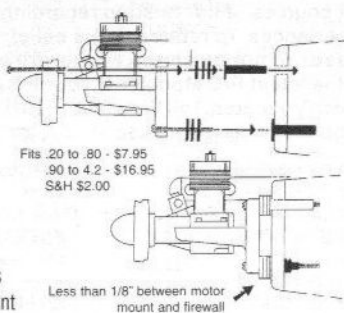

MASTER MOUNTS[®] by SoundMaster[®]

THE ULTIMATE BEAM MOUNT "Cradle Your Engine in Solid Safety"

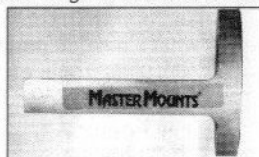
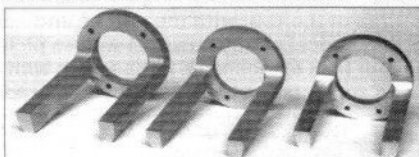

- Machined from one piece of aluminum bar stock
- 30% lighter than a cast aluminum mount
- Helps your engine run cooler
- Available for .60 to 1.20 cu. in.

- No tapping—just drill and bolt
- Strongest mount you can buy
- Rigid construction—not soft plastic
- Use with Iso-Mounts

get a grip

DAVIS
 MODEL PRODUCTS
 ACCESSORIES

START-R-STIK

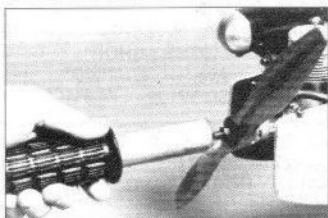

Industrial Strength Flipping Stick
 "Your hands are your hobby!"
 Regular to 14" props \$6.95
 Large 18" and up props \$7.95
 S&H \$2.00

POCKET DRILL SET



The Only All-In-One Pin Vise
 "Ideal Field Kit Tool!"
 Steel Collet with 12 Drill Bits
 List \$14.95 / Special \$9.99
 S&H \$2.00

CLIP-ITS



Mini-Hose Clamps
 "Secure your life lines!"
 No Fuel • No Pressure • No Fly
 8-Pk, Regular \$3.95/Giant Scale \$4.25

P.O. Box 141 • Milford, CT 06460 • 203-877-1670 (VISA & MC) For complete catalog send \$5.00 (credited to 1st order)

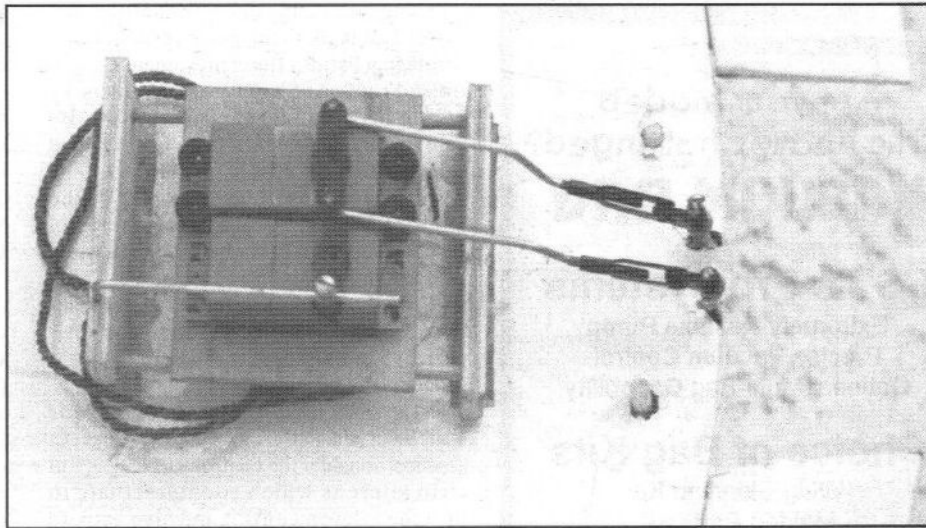
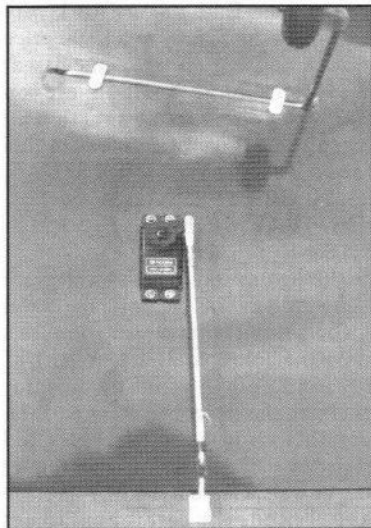

LEFT: Position of elevon servo on bottom of wing used with electronic mixing of elevons. RIGHT: Sliding tray set-up.

Back To The Wing:

Carve, plane, and sand the 3/16" leading edge undercaps and 1/4" trailing edge spars so sheeting will fit over the cores and these spars. Do not sand any of the core away.

Sheet the wings. We used Corefilm to apply the 1/16" x 2" leading and trailing edge, and 1/16" thick center section sheeting. Capstrips are 1/16" x 1/4" on 2" centers, glued in place.

Sand the leading edge and trailing edge sheeting flush with spars. Pin and CA 3/8" x 1" leading edge cap to leading edge. Pin and CA 1/4" tip plates to outboard ends of wing halves. Shape and sand leading

edge and wing and tip plates. (Note: Leading edge bottom is nearly flat and leading edge top curve is fairly steep.) Do not round the bottom leading edge; a max radius of 1/16" is desirable. Join wing halves with 5-minute epoxy.

Fit elevons to wing. We used X-Hinge to attach elevons to wing. (Note: If you use mechanical elevon mixing, form and install elevon control rods before you attach elevons.) Cut and cement end grain balsa into wing at bolt location to obviate crush of wing when bolting to the fuselage. Fit the 1/4" plywood wing plate into the leading edge of wing at center section. Set wing and wing

plate into place on fuselage and check for fit before gluing wing plate to wing. Now, using waxed or greased temporary 1/4" dowels, set wing and plate into place, align them, and glue plate to wing with 5-minute epoxy.

Place hardwood gear blocks at correct location on bottom of wing, mark area and remove sheeting and foam so that blocks are flush with sheeted bottom surface of wing. Glue these in place using 5-minute epoxy. Now, sand and cover wing. (Note: If you use electronic elevon mixing, install 1/8" ply servo plates, flush with bottom surface of the wing, and dig out foam for servo pocket prior to covering wing bottom.)

HOBBY SHOP BULLETIN

RCM has long maintained that the local hobby shop is one of your best sources of information regarding the R/C hobby. It also provides the opportunity and forum for the exchange of ideas and experiences. To reinforce this belief, RCM will be featuring each month different sections of the U.S. with the names and addresses of hobby shops where you can see and purchase "what's new" in modeling, share local hobby news, as well as pick-up the latest R/C Modeler. If your local shop does not carry RCM, please call, we will do our best to locate the hobby shop with RCM in your area. Toll Free (800) 523-1736. RCM would like to express its appreciation to Kalmbach, distributor of hobby related books to shops, for their assistance.

N.E.W. HOBBY

1234 S. Military Ave.
Green Bay, WI 54304

SPRING GREEN FLORAL & HOB.

1302 N. Central Ave.
Marshfield, WI 54449

ABC HOBBIES

1627 Losey Blvd. South
Lacrosse, WI 54601

HOBBY HAVEN

1507 Menomonee St.
Eau Claire, WI 54703

HOBBYTOWN USA

Aviation Plaza, 2061 S. Koeller
Oshkosh, WI 54901

BEST'S HOBBY CENTER, INC.

2700 W. College Ave. Suite #8
Appleton, WI 54914

FOCUS

75 South Main St.
Fond Du Lac, WI 54935

CHRISTOPHERS HOB. AND RC

212 W. Bridge
Owatonna, MN 55060

R/C CITY

696 West 7th St.
Saint Paul, MN 55102

HUB HOBBY CENTER

82 Minnesota Ave.
Little Canada, MN 55117

HOBBYTOWN USA

1960 Cliff Lake Road
Eagan, MN 55122

OUTLAW'S RC WORLD

7105 10th St. North
Oakdale, MN 55128

HOBBYTOWN USA

Hwy. 7 and 101
Minnetonka, MN 55345

JERRYSTOYS & HOBBY

2916 Pentagon Dr.
Minneapolis, MN 55418

HUB HOBBY CENTER

6416 Penn Ave. South
Richfield, MN 55423

HOBBY DEPOT LTD.

1208 E. 66th
Richfield, MN 55423

NATIONAL HOBBY COMPANY

1202 Moore Lake Dr. East
Fridley, MN 55432

LAKE SUPERIOR HOBBY

6301 Grand Avenue
Duluth, MN 55807

DON'S HOBBY CO.

424 South Front St.
Mankato, MN 56001

BEN FRANKLIN CRAFTS

1605 S. 1st St.
Willmar, MN 56201

BAKER'S CRAFT & HOBBY

2738 W. Division St.
Saint Cloud, MN 56301

TOMS PET & HOBBY SHOP

710 Laurel St.
Brainerd, MN 56401

HOBBY HUTCH

1201 Paul Bunyan Dr. N.W.
Bemidji, MN 56601

A & E RAILROAD

507 Riverside Dr.
Thief River Falls, MN 56701

UNIVERSAL HOBBY SHOP

222 S. Main Ave.
Sioux Falls, SD 57102

KLEINS

406 S. Wilson
Aberdeen, SD 57401

VALLEY HOBBIES, INC.

2714 Main
Fargo, ND 58103

HOBBYTOWN USA

2500-D S. Columbia Rd.
Grand Forks, ND 58201

MCGIFFINS, INC.

1200 S. Washington
Grand Forks, ND 58208

DAVES HOBBIES

200 W. Main Ave.
Bismarck, ND 58501

AEROPORT HOBBY SHOPPE

2112 N. Broadway
Minot, ND 58703

CENTRAL HOBBIES

1401 Central
Billings, MT 59102

BEN FRANKLIN

813 Main
Miles City, MT 59301

HOBBYTOWN USA

2825 W. Main St. 9/B
Bozeman, MT 59715

HOUSE OF HOBBIES

1008 N. 7th Ave.
Bozeman, MT 59715

THE TREASURE CHEST

1612 Benton Ave.
Missoula, MT 59801

NORTHLAND HOBBIES

1325 Hwy. 2 West
Kalispell, MT 59901

ARLINGTON HOBBIES & CRAFTS

218 N. Dunton
Arlington Heights, IL 60004

JIM'S HOBBIES LIMITED

814 Front St. #B
Mchenry, IL 60050

RON'S MUNDELEIN HOBBIES

431 N. Lake St.
Mundelein, IL 60060

Are your models
structurally challenged?

VACUUM BAG

CST's Pro Systems

Extremely Reliable Pump
Precise Vacuum Control
Optional Multi-Bag Capability

Choice of Bag Kits

Wing Skinning Kit
Molded Parts Kit
Deluxe Kit (for both)

Free Price List or \$5 for Complete Product Guide



Building with Today's Technology
Composite Structures Technology
PO Box 642, Dept. EL, Tehachapi, CA 93581
Order Toll Free: 1-800-338-1278
Technical Support: 805-822-4162

Complete, sand, and cover vertical fin. Cover fuselage, then epoxy vertical fin to fuselage. (Pattern fliers may change fin to fin and rudder.) Shape, cover, and epoxy 1/2" triangle fin fillets in place. (Note: Be sure to remove covering from fuselage and vertical fin in the areas of glue joints.)

For those new to the concept of the Simitar Series, an explanation of the control surface function and component installation will be helpful.

First, a Simitar requires only pitch (elevator) and roll (aileron) functions for perfect flight. Except for pattern flying, a rudder is not required.

Simitar control surfaces are elevons which serve as ailerons and elevators. In essence, consider the control surfaces as full strip ailerons which counteractuate to provide aileron control and also actuate simultaneously to provide elevator control. This means some form of mixing is needed. Such mixing can be provided by mechanical or electronic means.

The best mechanical method is to use my sliding tray, which works as follows: One of the servos in the tray is set up as you would for strip ailerons. The second servo is for elevator, and its control arm is attached to the stationary bulkhead at the front of the tray so that it will slide the tray fore and aft to give the elevator function.

Electronic mixing can be provided by either a radio with built-in mixing or by using Ace's Christy Mixer, or the Quillan Mixer which plug in-between the servos

and the receiver. Both mixers work very well and are in the \$25.00 to \$45.00 price range. Alternatively, some of the newer radio systems have built-in elevon mixing, or flaperon mixing functions. I have used several of the Futabas in this line, such as the 6VA, 7NFK, 7UAF, 7UAFS, 7UAP, and 9VP.

SLIDING TRAY MIXER

Control Set-Up:

The sliding tray fore and aft formers are of 1/4" ply. Drill the 1/8" holes for the dowel through both formers at the same time, this will make the holes parallel. Cut the 1/8" ply tray to fit both aileron and elevator servos. Push the dowels into one of the formers, then slide the red outer NyRod over each dowel, then push the other former onto the dowels. Cement the tray in place onto the NyRods (be careful not to get cement inside the NyRods), then install the servos as shown.

ELECTRONIC MIXER

Control Set-Up:

Use 1/8" ply trays to mount servos into wing; epoxy the trays flush on bottom of wing after sheeting. Grind a hole in the top center of the wing and use a piece of piano wire with a hook bent on one end to tunnel out for each servo lead. The lead is then easily fished through with a piece of string.

Final Assembly:

Install the landing gear, engine, fuel tank, and all the radio components. Hook up all the controls and check to make sure there is no binding. Check to make sure your air-

craft balances (level to slightly nosed down) at the location indicated on the plans (approximately 1-1/2" behind the leading edge of the wing, with no fuel in the tank).

Control Throws?

I put in as much as I can get, then use what I need (3/8" to 1/2" of up, down, left and right is fine). Remember, control is not like a light switch (on or off), it's like a dimmer switch, use only as much pressure on the stick as you need to make it do what you want!

Set the nose wheel height so that, while setting on a flat surface, the leading edge of the wing is 1/4" higher than the trailing edge (measured at the hinge line). Also, the trail-

ing edge of the elevons are set 1/8" up with the transmitter trim at neutral.

Check all surfaces for proper motion. (Remember, left aileron command results in the left elevon going up and the right going down; and the up elevator command results in both elevons going up.)

Flying:

Ah yes, flight performance of the Wiseguy is very smooth and graceful; gives the feeling that it's an extension of yourself in the air; seems to always do the right thing, often before you command it. Are the thumbs quicker than the eye? Bill Winter said to me, "Why does my Simitar do what I want it to

before I tell it to? Does it read my mind?"

Remember, be safe, be kind, have fun! And tight turns!



Reference Material

For more information about the development of the Simitar Series, refer to the following listings in *RCM*:

February '95, Zipity-do-dah (64" Fun Ship 28-40).
 March '91, Pole Star (50" Jet Looker 40-60).
 January '90, Leading Edge (twin fin 40 powered Jet Look).
 March '88, Desperado Sixty (60" anhedral rocket).
 March '88, Desperado 3000 (85", 17 lb., S.T. 3000 powered).
 August '86, Tracer 40 & 60 (pattern ships).
 March '85, Skywalker 1/2A (40 & 60).
 November '79, Astron 40 (X-Wing fighter).
 October '79, Simitar 540 (50" 40 power).
 December '76, Simitar (1/2A, the first Simitar).
 April '76, Saracen (72" glider, Bill's first flying wing).

